

336F L XE

Hydraulic Excavator

2017



Engine

Engine Model	Cat® C9.3 ACERT™	
Power – ISO 14396	234 kW	313 hp
Power – SAE J1349	228 kW	306 hp

Drive

Maximum Travel Speed	4.8 km/h	3 mph
Maximum Drawbar Pull	294 kN	66,139 lbf

Operating Weights

Minimum	37 100 kg	81,800 lb
Maximum	40 300 kg	88,800 lb

The 336F XE is the latest machine from Caterpillar that will significantly lower your owning and operating costs.

Built with our proven hydraulic hybrid system, this excavator will cut your fuel consumption by up to 20% compared to our standard 336E – a market leader in and of itself for high efficiency.

Unlike models from other manufacturers, the 336F XE is loaded with productivity boosting technology that will help improve your bottom line even more. Technologies like the new Cat Production Measurement Payload system, the Cat Grade 3D and Cat Grade with Assist, and Product Link™ are available on this machine – all to help you easily do work more quickly and efficiently.

So if you are looking for the absolute maximum level of productivity and efficiency from a 36-ton machine, look no further than the 336F XE.



Contents

Equipping Every Customer for Success4
Cat Hybrid Technology6
Fuel Efficient8
Reliable and Productive9
Easy to Operate10
Durable Structures12
Durable Linkages13
Versatile14
Cat Connect Technologies16
Safe Work Environment18
Serviceable19
Sustainable20
Complete Customer Care20
Specifications21
Standard Equipment34
Optional Equipment35



CAT

336F

LXE

HYBRID

GRADE CONTROL

Equipping Every Customer for Success

Building products just for you and your type of work.





Understanding your needs and requirements leads us to developing innovative products – products that help you win in a competitive environment. The 336F XE with hydraulic hybrid technology is the latest example of such an innovative product. This excavator is built for those of you who work machines long and hard and need the absolute highest level of productivity. When you see XE on a Cat machine, you can count on it being the most technologically advanced, fuel-efficient machine capable of working in all applications and material types.

Caterpillar also offers a traditional 336F model. This machine is built for those of you who also get paid by the job and are looking for a high level of productivity. Even though it isn't equipped with hydraulic hybrid technology, the 336F provides excellent fuel efficiency and productivity compared to competitive offerings.

So when you think of XE, think of the following attributes:

- Reliable, durable, and rebuildable
- Low cost per unit of work
- Breakthrough and innovative
- Maximum efficiency

When you think of the traditional model, think of these attributes:

- Reliable, durable, and rebuildable
- Low cost per unit of work
- Proven
- Highly efficient

No matter which model you choose, if it has the Cat brand on it, you can depend on it being a quality-made machine backed by the world's finest product support.

Cat Hybrid Technology

The more it works, the more you save.

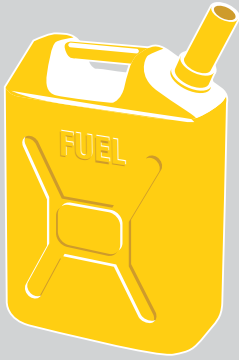

Up to
20%
less fuel consumption
than 336F – the fuel
economy and performance
leader in its size class



- 1 – Hydraulic Hybrid Swing System
- 2 – Electronic Standardized Programmable (ESP) Pump
- 3 – Adaptive Control System (ACS) Valve



The 336F LXE uses three building block technologies to deliver outstanding fuel savings and performance for you:

- The Cat Electronic Standardized Programmable (ESP) pump smoothly transitions between the hydraulic hybrid power sources, engine, and accumulator to conserve fuel.
- The Cat Adaptive Control System (ACS) valve optimizes performance by intelligently managing restrictions and flows to control machine motion.
- Instead of wasting kinetic energy during swing braking, the Cat Hydraulic Hybrid Swing System pressurizes the accumulator to stop the machine and then uses that pressure when needed to accelerate the machine later.

Bottom line: The hydraulic hybrid system is a simple, reliable, and cost-effective solution that will help you significantly reduce your cost per ton.

Our Smart Valve Is Smart For You

The 336F LXE's hydraulic hybrid system is unlike hybrid systems available from any other heavy equipment manufacturer in business today. The key ingredient is the ACS valve, which you can find only on the Cat brand.

Think of the ACS valve as the "brain" of the system – one that independently controls machine functions and directs hydraulic energy where you need it precisely when you need it. Because the ACS valve is fully integrated with the pump and hybrid system, you will experience the same extraordinary control, hydraulic power, and lift capacity that you get from our traditional high-production machines with the added benefit of dramatically reduced fuel consumption. That's why we are now offering the valve on our larger machines like the 374F and 390F.

Smart valve. Smart machine. Simply a smart investment for your business.

Fuel Efficient

Engineered to lower your operating costs.



The Cat C9.3 ACERT engine meets U.S. EPA Tier 4 Final emission standards and it does so without interrupting your job process. Simply turn the engine on and go to work. It will look for opportunities in your work cycle to regenerate itself, and it will give you plenty of power for the task at hand – all to help keep your owning and operating costs to an absolute minimum.

A Smart Design for Any Temperature

The 336F L features a side-by-side cooling system that allows you to put the machine to work in extremely hot and cold conditions. The system is completely separated from the engine compartment to reduce noise and heat. Plus it features easy-to-clean cores and a new variable-speed fan that reverses to blow out unwanted debris that may accumulate during your work day.

Biodiesel Not A Problem

The C9.3 ACERT engine can run on biodiesel fuel up to B20 blended with ULSD. Just fill it up and go.

Proven Technology

The right technologies fine-tuned for the right applications result in:

- **Improved Fuel Efficiency** – up to 20% fuel consumption savings, compared to 336E Tier 4 interim.
- **High Performance** across a variety of applications.
- **Enhanced Reliability** through commonality and simplicity of design.
- **Maximized Uptime and Reduced Cost** with world-class support from the Cat dealer network.
- **Minimized Impact of Emission Systems** – designed to be transparent to the operator without requiring interaction.
- **Durable Design** with long life to overhaul.
- **Delivering Better Fuel Economy** with minimized maintenance costs while providing the same great power and response.



Reliable and Productive
Power to move your material with speed
and precision.

Hydraulic Horsepower, a Cat Advantage

Hydraulic horsepower is the actual machine power available to do work through implements and work tools. It's much more than just the engine power under the hood – it's a core strength that differentiates Cat machines from other brands. In fact, pump and other system components work to put more power to the ground, in a highly controlled, user-friendly way. This means you will move more material in less time and keep more money in your pocket at the end of the day.

The heavy lift mode increases machine system pressure to improve lift – a nice benefit in certain situations. Heavy lift mode also reduces engine speed and pump flow in order to improve controllability.

Control Like No Other

Controllability is one of the main attributes of Cat excavators, and one of the key contributors to this is the main control valve. The valve opens slowly when your range of joystick lever movement is small and opens rapidly when movement is high. It puts flow where you need it when you need it, which leads to smoother operation, greater efficiency, and lower fuel consumption.

Auxiliary Hydraulics For Added Versatility

Auxiliary hydraulics give you greater tool versatility so you can take on more work with just one machine, and there are several options from which you can choose. A quick coupler circuit, for example, allows you to switch from one tool to another in a matter of minutes.

Easy to Operate

Comfort and convenience to keep you productive all day long.



Safe and Quiet Cab

Operators will enjoy the quietness and comfort of the all new cab thanks to special viscous mounts and special roof lining and sealing that limit vibration and unnecessary sound.

Excellent Ergonomics

Wide seats with air suspension and heat/cooling options, include a reclining back, upper and lower slide adjustments, and height and tilt angle adjustments to meet your needs for maximum comfort.

The fully automatic climate control system keeps operators comfortable and productive all day long in either hot or cold weather.

Storage spaces are located in the front, rear, and side consoles of the cab. A drink holder accommodates a large mug, and a shelf behind the seat stores large lunch or toolboxes.

Power supply sockets are available for charging your electronic devices like an MP3 player, a cell phone, or even a tablet.

Controls Just for You

The right and left joystick consoles can be adjusted to improve your comfort and productivity during the course of a day. The right joystick features a button that will reduce engine speed when you are not working to help save fuel. Touch it once and speed reduces; touch it again and speed increases for normal operation.



Easy to Navigate Monitor

The new LCD monitor is easy to see and navigate. Not only can it memorize up to 10 different work tools, it's also programmable in up to 44 languages to meet today's diverse workforce. The monitor clearly displays critical information you need to operate efficiently and effectively. Plus it projects the image from the rearview camera to help you see what's going on around you so you can stay safely focused on the job at hand.

Durable Structures

Made to work in your tough, heavy-duty applications.



Stable Undercarriage

The undercarriage contributes significantly to outstanding stability and durability.

Track shoes, links, rollers, idlers, and final drives are all built with high-tensile strength steel for long-term durability.

Cat Grease Lubricated Track 2 (GLT2) track link protects moving parts by keeping water, debris, and dust out and grease sealed in, which delivers longer wear life and reduced noise when traveling.

Optional guide guards help maintain track alignment to improve the machine's overall performance – whether you're traveling on a flat, heavy bed of rock or a steep, wet field of mud.

Robust Frames

You can expect excellent quality, reliability, and durability with the 336F XE. The machine's lower and upper frames are built to handle a hard day's work over and over again.

Great Weight

The 5.1 mt (5.6 t) and 6.1 mt (6.7 t) counterweights are available; with the heavier weight matched to a unique extreme service configuration that is designed to give you more lift.

Both counterweights are built with thick steel plates and reinforced fabrications to make it less susceptible to damage, designed with curved surfaces that match the machine's sleek, smooth appearance along with integrated housings to help protect the rearview camera.



Durable Linkages

Options to take on your far-reaching or up-close tasks.

Booms and Sticks For Any Job

The 336F XE is offered with a range of booms and sticks. Each is built with internal baffle plates and is stress relieved for added durability, and each undergoes ultrasound inspection to ensure quality and reliability. Large box-section structures with thick, multi-plate fabrications, castings, and forgings are used in high-stress areas such as the boom nose, boom foot, boom cylinder, and stick foot to improve durability. Also, the boom nose pin retention method is a captured flag design for enhanced durability.

The Reach boom and sticks offer you excellent all-around versatility for general excavations work like multipurpose digging and loading.

The Mass boom and sticks offer your enhanced performance in heavy-duty material like rock. They provide higher digging forces due to special boom and stick geometry, and bucket linkage and cylinders are built for greater durability.

Pins

All front linkage pins have thick chrome plating, giving them high wear resistance. Each pin diameter is made to distribute the shear and bending loads associated with the stick and to help ensure long pin, boom and stick life.

Talk to your Cat dealer to pick the best front linkage for your applications.

Versatile

Do more jobs with one machine.



Get the Most from One Machine

The Cat combination of machine and tool provides a total solution for just about any application. Work tools can be mounted either directly to the machine or to a quick coupler, making it fast and easy to release one work tool and pick up another.

Change Jobs Quickly

Cat quick coupler brings the ability to quickly change attachments and switch from job to job. The Cat coupler is the secure way to decrease downtime and increase job site flexibility and overall productivity.

Available tool control remembers pressures and flows for up to 10 tools. Simply toggle through the monitor, select the tool, and go to work for maximum efficiency.

Dig, Rip and Load

A wide range of buckets dig everything from basic top soil to extreme, harsh material like ore and high quartzite granite. Rip through rock as an alternative to blasting in quarries. High-capacity buckets load trucks in a minimum number of passes for maximum productivity.

Break, Demolish and Scrap

A hydraulic hammer ably equips your machine for breaking rock in quarries. It will also make taking down bridge pillars and heavily reinforced concrete on road demolition jobs no problem.

Multi-processor and pulverizer attachments make your machine ideal for demolition jobs and processing the resulting debris.

Shears with 360° rotation mount to the machine for processing scrap steel and metal.

Move and Handle

Add a thumb and you have the ability to move and handle brush, rocks, and debris. For constant material handling, a grapple is your solution. Choose from three different styles for picking, sorting, and loading trash, demolition debris, or recyclables.

Set Up Your Machine for Profitability

Your Cat dealer can install hydraulic kits to properly operate all Cat Work Tool attachments, maximizing the machine's uptime and your profit. All Cat Work Tool attachments are supported by the same Cat dealer network as your Cat machine.

GRAB, SORT, LOAD



Pro Series Hydraulic Thumbs



Stiff Link Thumbs



Demolition & Sorting Grapple



Contractors' Grapples



Trash Grapples

SWAP TOOLS



Center-Lock™ Pin Grabber Coupler

DIG & PACK



Ditch Cleaning and Tilt Buckets



General Duty Buckets



Heavy Duty Buckets



Severe Duty Buckets



Extreme Duty Buckets



Vibratory Plate Compactors

CUT, CRUSH, BREAK & RIP



Multi-Processors



Scrap & Demolition Shears



Secondary Pulverizers



Hydraulic Hammers



Rippers

Cat Connect Technologies

Monitor, manage, and enhance job site operations.



Cat Connect makes smart use of technology and services to improve your job site efficiency. Using the data from technology-equipped machines, you'll get more information and insight into your equipment and operations than ever before.

Cat Connect technologies offer improvements in these key areas:



EQUIPMENT
MANAGEMENT

Equipment Management – increase uptime and reduce operating costs.



PRODUCTIVITY

Productivity – monitor production and manage job site efficiency.



SAFETY

Safety – enhance job site awareness to keep your people and equipment safe.

PAYLOAD Technologies

Payload technologies accurately measure material being loaded or hauled. Payload data is shared with operators in real time to improve productivity, reduce overloading, and record progress.

Cat Production Measurement

Cat Production Measurement brings payload weighing to the cab, enabling operators to weigh loads “on the go.” Loads are weighed as the boom swings with no interruptions in the loading cycle, improving loading speed and efficiency. Operators can view load weights on the integrated display and know precisely how much material is in the bucket and when trucks are filled to target payload. Instant feedback gives operators the confidence to work more effectively, maximizing the potential of the entire fleet. Site managers can wirelessly access data via the VisionLink® web portal to measure production and monitor efficiency.



GRADE Technologies

Grade technologies combine digital design data and in-cab guidance to help you reach target grade quickly and accurately with minimal staking and checking. That means you'll be more productive, complete jobs faster, in fewer passes, using less fuel, at a lower cost.



Cat Grade with Assist

Cat Grade with Assist ensures you can dig a level base with the right slope each and every time; now it works with tilt buckets to give you even greater versatility. With a touch of a button, the simple-to-use system automates boom and bucket movements typically done by the operator. Regardless of your experience or skill, you will be able to reach target grade up to 45% faster than with traditional grading techniques.

Cat Grade 3D

Cat Grade 3D is perfect for complex excavating projects that require precise cuts and contours. The 254 mm (10 in) color monitor shows you exactly where to work and how much to cut or fill without staking or grade checking, delivering accuracy within 30 mm (1.18 in). Factory integration of most key components reduces field installation time and labor cost, making the system less costly for you compared to other options. Plus reliability is enhanced because built-in components are protected from damage, ensuring longer service life and more accurate results.

LINK Technologies

LINK technologies, like Product Link, are deeply integrated into your machine and wirelessly communicates key information, including location, hours, fuel usage, idle time and event codes.

Product Link/VisionLink

Easy access to Product Link data via the online VisionLink user interface can help you see how your machine or fleet is performing. You can use this information to make timely, fact based decisions that can boost job site efficiency and productivity, and lower costs.



Safe Work Environment

Features to help protect you day in and day out.

Secure Contact Points

Multiple large steps as well as hand and guard rails will get you into the cab as well as a leg up to the compartments.

Extended hand and guard rails allow you to safely climb to the upper deck. Anti-skid plates on the surface of the upper structure, and the top of the storage box area, reduce your slipping hazards in all types of weather conditions. They can be removed for cleaning.

Great Views

The rearview camera greatly enhances visibility behind the machine to help the operator work more productively. A panoramic rearview is automatically displayed on the new multi-function monitor during reverse travel. As an option, a second display can be added, providing a dedicated full-time rearview of the job site.

Smart Lighting

Halogen lights provide plenty of illumination. Cab and boom lights can be programmed to stay on for up to 90 seconds after the engine has been turned off to help you safely exit the machine.

A Safe and Quiet Cab

The ROPS-certified cab provides you with a safe working environment. It also contributes to your comfort because it's attached to a reinforced frame with special viscous mounts that limit vibration and unnecessary sound. Add in special roof lining and sealing and you have a cab that's as quiet inside as any of today's highway trucks.

Optional Falling Object Guards (FOGS) further protect you from debris coming to the cab.



Serviceable

Designed to make your maintenance quick and easy.

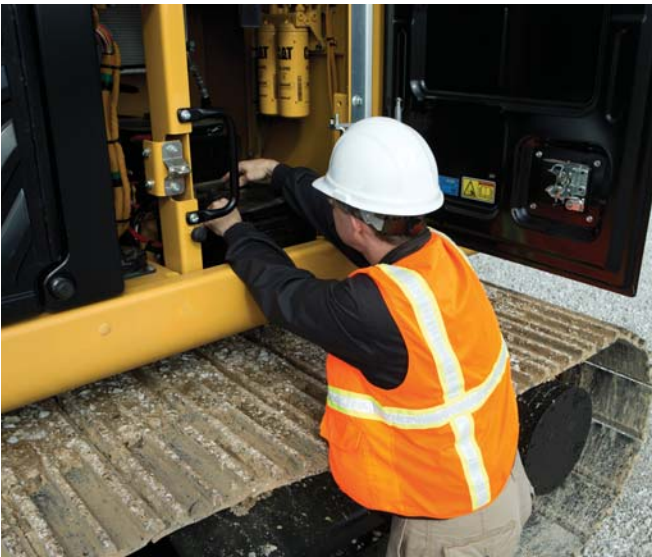

Ground-Level Access

You can reach most routine maintenance items like fuel and oil filters, fluid taps, and grease points from the safety and convenience of ground level. Not only do compartments feature wide service doors designed to help prevent debris entry, but they also securely latch in place to help make your service work simpler.

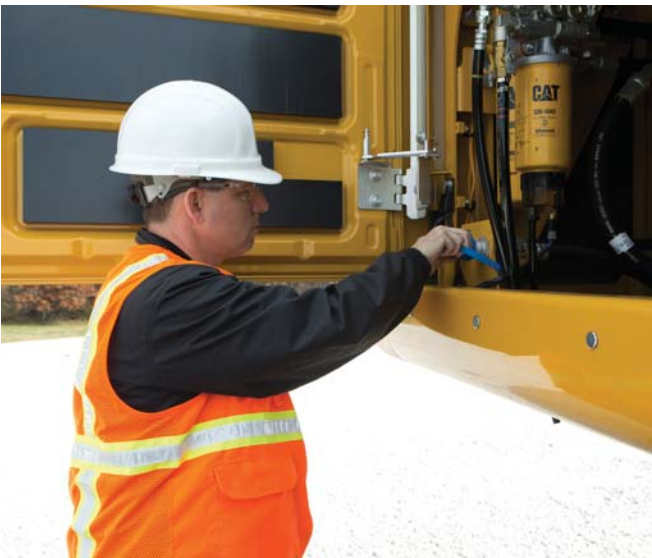

Quick and Convenient Fluids Service

S-O-SSM Oil sample and pressure ports provide easy checking of machine condition and are standard on every machine.

You can ensure fast, easy, and secure changing of engine and hydraulic oil with the QuickEvacTM option.

The fuel tank's drain cock makes it easy and simple for you to remove water and sediment during routine maintenance. Plus an integrated fuel level indicator pops up to help you reduce the possibility of fuel tank overfilling. An optional fast fill port accessible from ground level can make refueling even easier and faster.



A Smart Cooling Design

The high-ambient cooling system features a fuel-saving variable-speed fan and a side-by-side-mounted radiator and oil and air coolers for easy cleaning.

A Fresh Idea

When you select ventilation inside the cab, outside air enters through the fresh air filter. The filter is conveniently located on the side of the cab to make it easy to reach and replace, and it is protected by a lockable door that can be opened with the engine key.

HYBRID

Sustainable Generations ahead in every way.

The 336F XE is designed to compliment your business plan, reduce emissions and minimize the consumption of natural resources.

- The 336F XE moves as much material as a standard 336F yet burns up to 20% less fuel. This means more efficiency and productivity for you with less resource consumption
- The C9.3 ACERT engine meets Tier 4 Final emission standards.
- The machine has the flexibility of running on either ultra-low-sulfur diesel (ULSD) fuel with 15 ppm for EPA, 10 ppm for EU of sulfur or less or up to bio diesel (B20) fuel blended with ULSD.
- An overfill indicator rises when the tank is full to help the operator avoid spilling.
- Quick fill ports with connectors ensure fast, easy, and secure changing of hydraulic oil.
- Major components are rebuildable, eliminating waste and saving money by giving the machine and/or major components a second life – and even a third life.
- Link technologies enable you to collect and analyze equipment and job site data so you can maximize productivity and reduce costs.
- The 336F XE is an efficient, productive machine that's designed to conserve our natural resources for generations ahead.

Complete Customer Care Unmatched support makes the difference.

Worldwide Parts Availability

Cat dealers utilize a worldwide parts network to maximize your machines' uptime. Plus they can help you save money with Cat remanufactured components.

Financial Options Just for You

Consider financing options and day-to-day operating costs. Look at dealer services that can be included in the machine's cost to yield lower owning and operating costs over time.

What's Best for You Today...and Tomorrow

Repair, rebuild, or replace? Your Cat dealer can help you evaluate the cost involved so you can make the best choice for your business.



336F L XE Hydraulic Excavator Specifications

Engine

Engine Model	Cat C9.3 ACERT	
Gross Power – SAE J1995	238 kW	319 hp
Gross Power – ISO 14396	234 kW	313 hp
Net Power – SAE J1349	228 kW	306 hp
Bore	115 mm	4.53 in
Stroke	149 mm	5.87 in
Displacement	9.3 L	568 in ³

Weights

Minimum Operating Weight	37 100 kg	81,800 lb
Maximum Operating Weight	40 300 kg	88,800 lb

Hydraulic System

Maximum Flow (Total)		
Main System	570 L/min	151 gal/min
Swing System	276 L/min	73 gal/min
Pilot System	28 L/min	7 gal/min
Maximum Pressure		
Main System – Normal	35 000 kPa	5,076 psi
Main System – Heavy Lift	37 000 kPa	5,366 psi
Main System – Travel	35 000 kPa	5,076 psi
Main System – Swing	31 500 kPa	4,569 psi
Pilot System	4100 kPa	595 psi
Boom Cylinder – Bore	150 mm	5.9 in
Boom Cylinder – Stroke	1440 mm	56.7 in
Stick Cylinder – Bore	170 mm	6.7 in
Stick Cylinder – Stroke	1738 mm	68.4 in
DB Bucket Cylinder – Bore	150 mm	5.9 in
DB Bucket Cylinder – Stroke	1151 mm	45.3 in
TB Bucket Cylinder – Bore	160 mm	6.3 in
TB Bucket Cylinder – Stroke	1356 mm	53.4 in

Track

Track Options	600 mm	24 in
	700 mm	28 in
	800 mm	32 in
	850 mm	34 in
Number of Shoes Each Side	49	
Number of Track Rollers Each Side	9	
Number of Carrier Rollers Each Side	2	

Drive

Gradeability	30°/70%	
Maximum Travel Speed	4.8 km/h	3 mph
Maximum Drawbar Pull	294 kN	66,139 lbf

Swing

Swing Speed	8.7 rpm	
Swing Torque	109 kN·m	80,144 lbf-ft
Maximum Swing Torque	134 kN·m	98,833 lbf-ft

Service Refill Capacities

Fuel Tank Capacity	620 L	164 gal
Cooling System	43 L	11 gal
Engine Oil (with filter)	32 L	8 gal
Swing Drive (each)	19 L	5 gal
Final Drive (each)	8 L	2 gal
Hydraulic System (including tank)	380 L	100 gal
Hydraulic Tank	175 L	46 gal
Diesel Exhaust Fluid (DEF) Tank	41 L	11 gal

Sound Performance

Exterior – ISO 6395*	105 dB(A)
Operator – SAE J1166/ISO 6396	73 dB(A)

- Hearing protection may be needed when operating with an open operator station and cab (when not properly maintained or doors/windows open) for extended periods or in a noisy environment.
- When properly installed and maintained, the cab offered by Caterpillar, when tested with doors and windows closed according to ANSI/SAE J1166 OCT98, meets OSHA and MSHA requirements for operator sound exposure limits in effect at time of manufacture.

*as per European Union Directive 2000/14/EC as amended by 2005/88/EC

Standards

Brakes	SAE J1026/APR90
	ISO 10265:2008
Cab/FOGS	SAE J1356 FEB88
	ISO 10262:2008
Cab/ROPS	ISO 12117-2:2008
DEF	ISO 22241

336F L XE Hydraulic Excavator Specifications

Dimensions

All dimensions are approximate.

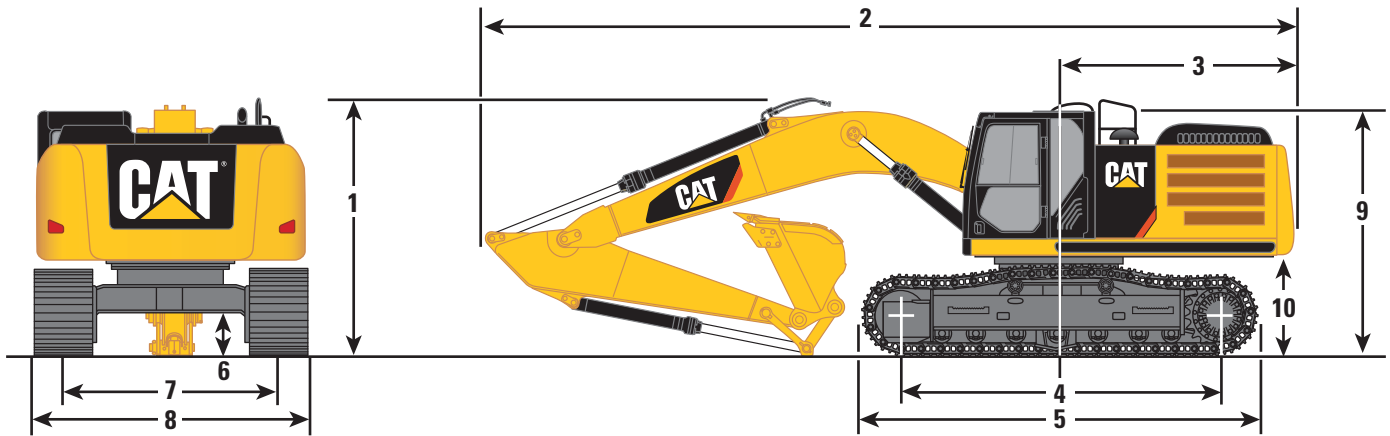

Boom Options	Reach Boom 6.50 m (21'4")			Mass Boom 6.18 m (20'3")
Stick Options	R3.9DB (12'10")	R3.2DB (10'6")	R2.8DB (9'2")*	M2.55TB (8'4")
1 Shipping Height including Shoe Lug Height	3660 mm (12'0")	3510 mm (11'6")	3650 mm (12'0")	3600 mm (11'10")
2 Shipping Length	11 200 mm (36'9")	11 190 mm (36'9")	11 220 mm (36'10")	10 920 mm (35'10")
3 Tail Swing Radius	3490 mm (11'5")	3490 mm (11'5")	3490 mm (11'5")	3490 mm (11'5")
4 Length to Center of Rollers	4040 mm (13'3")	4040 mm (13'3")	4040 mm (13'3")	4040 mm (13'3")
5 Track Length	5030 mm (16'6")	5030 mm (16'6")	5030 mm (16'6")	5030 mm (16'6")
6 Ground Clearance including Shoe Lug Height	510 mm (1'8")	510 mm (1'8")	510 mm (1'8")	510 mm (1'8")
Ground Clearance without Shoe Lug Height	480 mm (1'7")	480 mm (1'7")	480 mm (1'7")	480 mm (1'7")
7 Track Gauge	2590 mm (8'6")	2590 mm (8'6")	2590 mm (8'6")	2590 mm (8'6")
8 Transport Width				
600 mm (24") Shoes	3190 mm (10'6")	3190 mm (10'6")	3190 mm (10'6")	3190 mm (10'6")
700 mm (28") Shoes	3290 mm (10'10")	3290 mm (10'10")	3290 mm (10'10")	3290 mm (10'10")
800 mm (32") Shoes	3390 mm (11'1")	3390 mm (11'1")	3390 mm (11'1")	3390 mm (11'1")
850 mm (34") Shoes	3440 mm (11'3")	3440 mm (11'3")	3440 mm (11'3")	3440 mm (11'3")
9 Cab Height	3150 mm (10'4")	3150 mm (10'4")	3150 mm (10'4")	3150 mm (10'4")
Cab Height with Top Guard	3360 mm (11'0")	3360 mm (11'0")	3360 mm (11'0")	3360 mm (11'0")
10 Counterweight Clearance without Shoe Lug Height	1220 mm (4'0")	1220 mm (4'0")	1220 mm (4'0")	1220 mm (4'0")
Buckets				
Type	DB1536GP-C	DB1536GP-C	DB1536GP-C	TB1676SD
Capacity	2.28 m ³ (2.98 yd ³)	2.28 m ³ (2.98 yd ³)	2.28 m ³ (2.98 yd ³)	2.41 m ³ (3.15 yd ³)
Tip Radius	1753 mm (5'9")	1753 mm (5'9")	1753 mm (5'9")	1895 mm (6'2")

*For ANZ only.

336F L XE Hydraulic Excavator Specifications

Working Ranges

All dimensions are approximate.

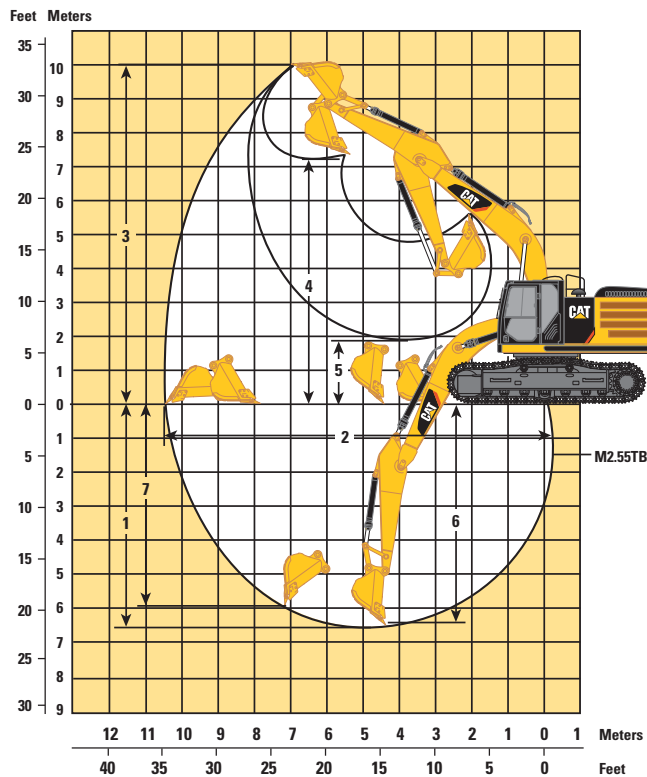
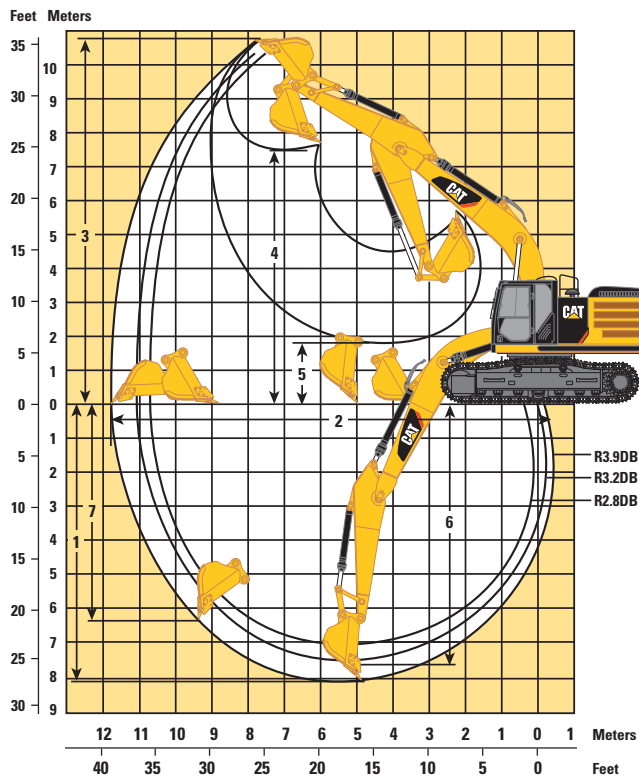

Boom Options

Reach Boom 6.50 m (21'4")

Mass Boom 6.18 m (20'3")

Stick Options

R3.9DB (12'10")

R3.2DB (10'6")

R2.8DB (9'2")*

M2.55TB (8'4")

1 Maximum Digging Depth	8190 mm (26'10")	7490 mm (24'7")	7090 mm (23'3")	6650 mm (21'10")
2 Maximum Reach at Ground Level	11 720 mm (38'5")	11 020 mm (36'2")	10 710 mm (35'2")	10 260 mm (33'8")
3 Maximum Cutting Height	10 740 mm (35'3")	10 320 mm (33'10")	10 370 mm (34')	9970 mm (32'9")
4 Maximum Loading Height	7500 mm (24'7")	7110 mm (23'4")	7110 mm (23'4")	6620 mm (21'9")
5 Minimum Loading Height	1910 mm (6'3")	2610 mm (8'7")	3010 mm (9'11")	2920 mm (9'7")
6 Maximum Depth Cut for 2440 mm (8'0") Level Bottom	7610 mm (25'0")	6820 mm (22'5")	6390 mm (21')	5810 mm (19'1")
7 Maximum Vertical Wall Digging Depth	6310 mm (20'8")	5500 mm (18'1")	5470 mm (17'11")	4450 mm (14'7")

Buckets

Type	DB1536GP-C	DB1536GP-C	DB1536GP-C	TB1676SD
Capacity	2.28 m ³ (2.98 yd ³)	2.28 m ³ (2.98 yd ³)	2.28 m ³ (2.98 yd ³)	2.41 m ³ (3.15 yd ³)
Tip Radius	1753 mm (5'9")	1753 mm (5'9")	1753 mm (5'9")	1895 mm (6'2")

*For ANZ only.

336F L XE Hydraulic Excavator Specifications

Major Component Weights*

	kg	lb
Lower Structure (without counterweight and track)	8900	19,600
Upper Structure (without front linkage)		
For 5.1 mt (5.6 t) Counterweight	10 700	23,600
For 6.1 mt (6.7 t) Counterweight	11 200	24,700
Counterweight		
5.1 mt (5.6 t)	5100	11,200
6.1 mt (6.7 t)	6100	13,400
Boom (includes lines, pins and stick cylinder)		
ES Reach Boom – 6.50 m (21'4")	4300	9,500
HD Reach Boom – 6.50 m (21'4")	4100	9,000
Mass Boom – 6.18 m (20'3")	4200	9,300
Stick (includes lines, pins and bucket cylinder)		
R3.9DB ES (12'10")**	2100	4,600
R3.2DB ES (10'6")**	1900	4,200
R3.9DB HD (12'10")	1900	4,200
R3.2DB HD (10'6")	1800	4,000
R2.8DB HD (10'6")***	1800	4,000
M2.55TB (8'4")	2100	4,600
Track Shoe		
600 mm (24") Double Grouser***		
600 mm (24") Triple Grouser***		
700 mm (28") Triple Grouser***		
800 mm (32") Triple Grouser	5100	11,200
850 mm (34") Triple Grouser	5400	11,900
Quick Coupler	600	1,300
Bucket		
DB1536GP-C 2.28 m ³ (2.98 yd ³)	1500	3,300
TB1676SD 2.41 m ³ (3.15 yd ³)	2500	5,500

*Base machine includes 75 kg (165 lb) operator weight and 90% fuel weight, and undercarriage with center guard.

**For AmN only.

***For ANZ only.

336F L XE Hydraulic Excavator Specifications

Operating Weights and Ground Pressures

	850 mm (33")		800 mm (31")		700 mm (28")*		600 mm (24")*		600 mm (24")*	
	Triple Grouser Shoes	Triple Grouser Shoes	Triple Grouser Shoes	Triple Grouser Shoes	Triple Grouser Shoes	Triple Grouser Shoes	Triple Grouser Shoes	Double Grouser Shoes	Double Grouser Shoes	Double Grouser Shoes
	kg (lb)	kPa (psi)	kg (lb)	kPa (psi)	kg (lb)	kPa (psi)	kg (lb)	kPa (psi)	kg (lb)	kPa (psi)
5.1 mt (5.6 t) Counterweight										
HD Reach Boom – 6.5 m (21'4")										
HD R3.9DB (12'10")	37 500 (82,700)	49.3 (7.2)	37 200 (82,000)	52.0 (7.5)	36 600 (80,700)	58.4 (8.5)	36 200 (79,800)	67.4 (9.8)	37 100 (81,800)	69.1 (10.0)
HD R3.2DB (10'6")	37 400 (82,500)	49.2 (7.1)	37 100 (81,800)	51.8 (7.5)	36 400 (80,200)	58.1 (8.4)	36 100 (79,600)	67.2 (9.8)	36 900 (81,400)	68.7 (10.0)
HD R2.8DB (9'2")*	37 400 (82,500)	49.2 (7.1)	37 100 (81,800)	51.8 (7.5)	36 400 (80,200)	58.1 (8.4)	36 100 (79,600)	67.2 (9.8)	36 900 (81,400)	68.7 (10.0)
Mass Boom – 6.18 m (20'3")										
M2.55TB (8'4")	38 700 (85,300)	50.9 (7.4)	38 400 (84,700)	53.6 (7.8)	37 800 (83,300)	60.4 (8.8)	37 400 (82,500)	69.7 (10.1)	38 300 (84,400)	71.3 (10.3)
6.1 mt (6.7 t) Counterweight										
HD Reach Boom – 6.5 m (21'4")										
HD R3.9DB (12'10")	39 100 (86,200)	51.4 (7.5)	38 800 (85,500)	54.2 (7.9)	38 100 (84,000)	60.8 (8.8)	37 800 (83,300)	70.4 (10.2)	38 600 (85,100)	71.9 (10.4)
HD R3.2DB (10'6")	38 900 (85,800)	51.1 (7.4)	38 600 (85,100)	53.9 (7.8)	37 900 (83,600)	60.5 (8.8)	37 600 (82,900)	70.0 (10.2)	38 400 (84,700)	71.5 (10.4)
HD R2.8DB (9'2")*	38 900 (85,800)	51.1 (7.4)	38 600 (85,100)	53.9 (7.8)	37 900 (83,600)	60.5 (8.8)	37 600 (82,900)	70.0 (10.2)	38 400 (84,700)	71.5 (10.4)
ES Reach Boom – 6.5 m (21'4")										
ES R3.9DB (12'10")**	39 400 (86,900)	51.8 (7.5)	39 200 (86,400)	54.8 (7.9)						
ES R3.2DB (10'6")**	39 200 (86,400)	51.5 (7.5)	38 900 (85,800)	54.3 (7.9)						
Mass Boom – 6.18 m (20'3")										
M2.55TB (8'4")	40 300 (88,800)	53.0 (7.7)	40 000 (88,200)	55.9 (8.1)	39 300 (86,600)	62.7 (9.1)	39 000 (86,000)	72.6 (10.5)	39 800 (87,700)	74.1 (10.8)

*For ANZ only.
**For AmN only

336F L XE Hydraulic Excavator Specifications

Bucket and Stick Forces

Boom Options	HD Reach Boom 6.50 m (21'4")			Mass Boom 6.18 m (20'3")
Stick Options	R3.9 DB (12'10")	R3.2 DB (10'6")	R2.8 DB (9'2")	M2.55 TB (8'4")
	kN (lbf)	kN (lbf)	kN (lbf)	kN (lbf)
General Duty				
Bucket Digging Force (ISO)	211.8 (47,610)	211.8 (47,610)	211.8 (47,610)	264.9 (59,550)
Stick Digging Force (ISO)	144.9 (32,570)	166.7 (37,480)	185.5 (41,700)	190.8 (42,890)
Bucket Digging Force (SAE)	188.5 (42,380)	188.5 (42,380)		234.7 (52,760)
Stick Digging Force (SAE)	141.5 (31,810)	162.1 (36,440)		184.6 (41,500)
Heavy Duty				
Bucket Digging Force (ISO)	209.9 (47,190)	209.9 (47,190)	209.9 (47,190)	264.9 (59,550)
Stick Digging Force (ISO)	144.5 (32,480)	166.1 (37,340)	184.8 (41,540)	190.8 (42,890)
Bucket Digging Force (SAE)	184.9 (41,570)	184.9 (41,570)		234.7 (52,760)
Stick Digging Force (SAE)	140.7 (31,630)	161.1 (36,220)		184.6 (41,500)
Severe Duty				
Bucket Digging Force (ISO)	209.9 (47,190)	209.9 (47,190)	209.9 (47,190)	261.4 (58,770)
Stick Digging Force (ISO)	144.5 (32,480)	166.1 (37,340)	184.8 (41,540)	190.2 (42,760)
Bucket Digging Force (SAE)	184.9 (41,570)	184.9 (41,570)		231.0 (51,930)
Stick Digging Force (SAE)	140.7 (31,630)	161.1 (36,220)		183.9 (41,340)
Extreme Duty				
Bucket Digging Force (ISO)	209.9 (47,190)	209.9 (47,190)	209.9 (47,190)	
Stick Digging Force (ISO)	144.5 (32,480)	166.1 (37,340)	184.8 (41,540)	
Bucket Digging Force (SAE)	184.9 (41,570)	184.9 (41,570)		
Stick Digging Force (SAE)	140.7 (31,630)	161.1 (36,220)		

Caterpillar recommends using appropriate work tools to maximize the value customers receive from our products. Use of work tools, including buckets, which are outside of Caterpillar's recommendations or specifications for weight, dimensions, flows, pressures, etc. may result in less-than-optimal performance, including but not limited to reductions in production, stability, reliability, and component durability. Improper use of a work tool resulting in sweeping, prying, twisting and/or catching of heavy loads will reduce the life of the boom and stick.

336F L XE Hydraulic Excavator Specifications

Reach Boom Lift Capacities – Counterweight: 6.1 mt (6.7 t) – Heavy Lift: On

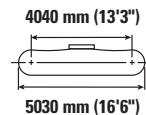
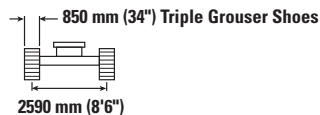
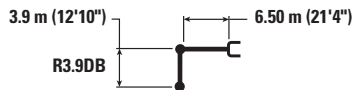

		1500 mm/60 in		3000 mm/120 in		4500 mm/180 in		6000 mm/240 in		7500 mm/300 in		9000 mm/360 in		mm in		
9000 mm 360 in	kg lb													*6050 *13,450	*6050 *13,450	7350 290
7500 mm 300 in	kg lb									*7450 *16,450	*7450 *16,450			*5650 *12,450	*5650 *12,450	8540 340
6000 mm 240 in	kg lb									*7750 *16,950	*7750 *16,950	*7300 16150	6150 13,150	*5450 *12,050	*5450 *12,050	9340 370
4500 mm 180 in	kg lb							*9450 *20,500	*9450 *20,500	*8500 *18,450	8050 17,300	*7900 *17,300	6050 12,950	*5500 *12,050	5200 11,450	9840 390
3000 mm 120 in	kg lb					*14 800 *31,850	*14 800 *31,850	*11 200 *24,250	10 700 23,050	*9400 *20,450	7700 16,600	*8400 *18,300	5850 12,600	*5650 *12,450	4900 10,750	10 100 400
1500 mm 60 in	kg lb					*17 850 *38,500	15 200 32,750	*12 900 *27,850	10 100 21,800	*10 350 *22,500	7400 15,950	8850 19,050	5700 12,250	*6000 *13,150	4750 10,500	10 130 400
0 mm 0 in	kg lb			*8250 *18,800	*8250 *18,800	*19 450 *42,050	14 550 31,300	*14 050 *30,400	9700 20,900	*11 100 *24,000	7150 15,350	8700 18,750	5550 11,950	*6550 *14,400	4850 10,650	9930 390
-1500 mm -60 in	kg lb	*8650 *19,300	*8650 *19,300	*12 900 *29,200	*12 900 *29,200	*19 700 *42,650	14 300 30,750	*14 500 *31,350	9450 20,400	11 200 24,050	7000 15,050	8650 18,600	5450 11,800	*7400 *16,350	5100 11,250	9490 380
-3000 mm -120 in	kg lb	*13 700 *30,600	*13 700 *30,600	*18 850 *42,600	*18 850 *42,600	*18 850 *40,800	14 300 30,800	*14 150 *30,550	9400 20,300	*11 050 *23,850	6950 15,000			*8950 *19,700	5700 12,600	8770 350
-4500 mm -180 in	kg lb	*19 600 *44,100	*19 600 *44,100	*23 250 *50,200	*23 250 *50,200	*16 800 *36,200	14 550 31,300	*12 750 *27,350	9550 20,600	*9550 *20,150	7100 15,350			*9150 *20,100	6900 15,350	7690 300
-6000 mm -240 in	kg lb					*12 800 *26,950	*12 800 26,950	*9050 *9050						*8900 *19,500	*8900 *19,500	6060 240



ISO 10567



* Indicates that the load is limited by hydraulic lifting capacity rather than tipping load. The above loads are in compliance with hydraulic excavator lift capacity standard ISO 10567:2007. They do not exceed 87% of hydraulic lifting capacity or 75% of tipping load. Weight of all lifting accessories must be deducted from the above lifting capacities. Lifting capacities are based on the machine standing on a firm, uniform supporting surface. The use of a work tool attachment point to handle/lift objects, could affect the machine lift performance.

Lift capacity stays with ±5% for all available track shoes.

Always refer to the appropriate Operation and Maintenance Manual for specific product information.

336F L XE Hydraulic Excavator Specifications

Reach Boom Lift Capacities – Counterweight: 6.1 mt (6.7 t) – Heavy Lift: On

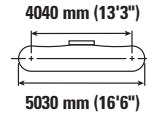
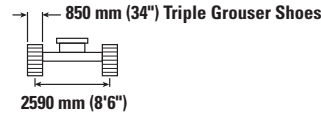
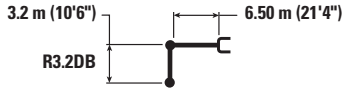

		3000 mm/120 in		4500 mm/180 in		6000 mm/240 in		7500 mm/300 in		9000 mm/360 in		mm in		
7500 mm 300 in	kg lb							*8500	8250			*7200 *15,900	*7200 *15,900	7700 300
6000 mm 240 in	kg lb							*8600 *18,850	8200 17,550			*7000 *15,400	6550 14,550	8580 340
4500 mm 180 in	kg lb			*13 100	*13 100	*10 550 *22,800	*10 550 *22,800	*9250 *20,150	7950 17,100	*8250	6000	*7050 *15,500	5850 12,900	9130 360
3000 mm 120 in	kg lb			*16 600 *35,600	15 900 34,250	*12 200 *26,350	10 550 22,700	*10 100 *21,900	7650 16,500	*8950	5850 12,550	*7300 *16,100	5450 12,050	9410 370
1500 mm 60 in	kg lb			*19 050 *41,150	14 950 32,200	*13 650 *29,500	10 000 21,600	*10 900 *23,650	7400 15,900	8900	5700 12,300	*7850 *17,250	5350 11,750	9440 380
0 mm 0 in	kg lb			*19 900 *43,100	14 550 31,250	*14 500 *31,350	9700 20,900	11 400 24,500	7150 15,450	8750	5600 12,100	8500 18,650	5450 11,950	9220 370
-1500 mm -60 in	kg lb	*14 100 *31,900	*14 100 *31,900	*19 500 *42,300	14 450 31,050	*14 600 *31,550	9550 20,600	11 250 24,250	7100 15,250			9100 20,050	5800 12,800	8750 350
-3000 mm -120 in	kg lb	*22 200 *50,300	*22 200 *50,300	*18 100 *39,150	14 550 31,300	*13 800 *29,800	9600 20,650	*10 700 *22,900	7100 15,350			*9750 *21,550	6600 14,650	7960 320
-4500 mm -180 in	kg lb	*20 350 *43,800	*20 350 *43,800	*15 350 *32,950	14 850 32,000	*11 650 *24,750	9800 21,200					*9800 *21,600	8400 18,800	6750 270

Reach Boom Lift Capacities – Counterweight: 6.1 mt (6.7 t) – Heavy Lift: On

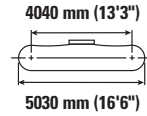
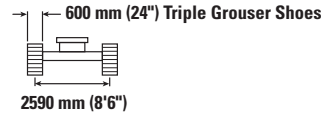
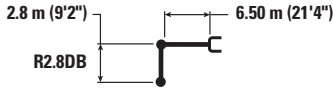

		3000 mm/120 in		4500 mm/180 in		6000 mm/240 in		7500 mm/300 in		9000 mm/360 in		mm in		
7500 mm 300 in	kg lb											*9100 *20,150	8200 18,400	7340 290
6000 mm 240 in	kg lb					*9750 *21,200	*9750 *21,200	*9100 *19,900	7850 16,850			*8750 *19,300	6700 14,900	8250 330
4500 mm 180 in	kg lb			*14 050 *30,150	*14 050 *30,150	*11 100 *23,950	10 650 23,000	*9650 *20,950	7650 16,450			*8750 *19,250	5900 13,100	8820 350
3000 mm 120 in	kg lb			*17 450 *37,500	15 100 32,650	*12 650 *27,350	10 100 21,800	*10 400 *22,600	7350 15,850	8700	5650	8550 18,850	5500 12,150	9110 360
1500 mm 60 in	kg lb			*16 900 *41,150	14 300 30,800	*13 950 *30,150	9650 20,750	*11 150 *24,100	7100 15,300	8550	5500	8400 18,450	5400 11,850	9140 360
0 mm 0 in	kg lb			*19 850 *43,050	14 000 30,150	*14 600 *31,600	9350 20,150	11 000 23,650	6950 14,950			8600 18,950	5500 12,100	8920 350
-1500 mm -60 in	kg lb	*13 150 *29,950	*13 150 *29,950	*19 150 *41,500	14 000 30,150	*14 450 *31,350	9250 19,950	10 950 23,500	6850 14,800			9300 20,550	5950 13,050	8420 340
-3000 mm -120 in	kg lb	*22 850 *49,700	*22 850 *49,700	*17 400 *37,700	14 200 30,500	*13 400 *28,900	9350 20,100	*10 150	6950			*9950 *21,850	6850 15,200	7600 300
-4500 mm -180 in	kg lb	*18 250 *39,250	*18 250 *39,250	*14 200 *30,400	*14 200 *30,400	*10 600 *22,200	9650 20,850					*9700 *21,250	9050 20,250	6330 250



ISO 10567



* Indicates that the load is limited by hydraulic lifting capacity rather than tipping load. The above loads are in compliance with hydraulic excavator lift capacity standard ISO 10567:2007. They do not exceed 87% of hydraulic lifting capacity or 75% of tipping load. Weight of all lifting accessories must be deducted from the above lifting capacities. Lifting capacities are based on the machine standing on a firm, uniform supporting surface. The use of a work tool attachment point to handle/lift objects, could affect the machine lift performance.









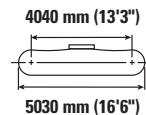
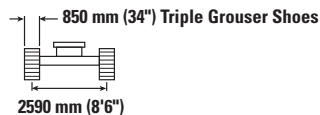
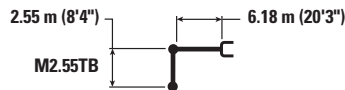

Lift capacity stays with ±5% for all available track shoes.

Always refer to the appropriate Operation and Maintenance Manual for specific product information.

336F L XE Hydraulic Excavator Specifications

Mass Boom Lift Capacities – Counterweight: 6.1 mt (6.7 t) – Heavy Lift: On



		3000 mm/120 in		4500 mm/180 in		6000 mm/240 in		7500 mm/300 in				mm in
												
7500 mm 300 in	kg lb					*9850 *21,800	*9850 *21,800			*8850 *19,550	*8850 *19,550	6580 260
6000 mm 240 in	kg lb					*10 200 *22,250	*10 200 *22,250	*9650	7800	*8400 *18,550	7650 17,050	7600 300
4500 mm 180 in	kg lb			*14 250 *30,600	*14 250 *30,600	*11 350 *24,550	10 750 23,200	*9950 *21,700	7650 16,450	*8400 *18,500	6600 14,650	8210 330
3000 mm 120 in	kg lb			*17 400 *37,450	15 350 33,150	*12 750 *27,600	10 200 22,000	*10 550 *22,950	7400 15,900	*8750 *19,200	6100 13,450	8520 340
1500 mm 60 in	kg lb			*19 350 *41,800	14 550 31,300	*13 950 *30,150	9750 21,000	*11 150 *24,200	7150 15,400	*9400 *20,650	5950 13,100	8550 340
0 mm 0 in	kg lb			*19 550 *42,400	14 250 30,650	*14 450 *31,250	9450 20,400	11 200 24,150	7000 15,100	9700 21,350	6100 13,450	8310 330
-1500 mm -60 in	kg lb	*17 900 *40,600	*17 900 *40,600	*18 600 *40,300	14 250 30,700	*14 050 *30,450	9400 20,250	*10 900 *23,400	7000 15,050	*10 300 *22,700	6700 14,750	7780 310
-3000 mm -120 in	kg lb	*21 300 *46,200	*21 300 *46,200	*16 400 *35,450	14 500 31,200	*12 500 *26,800	9550 20,600			*10 300 *22,700	8000 17,750	6880 270
-4500 mm -180 in	kg lb			*12 050 *25,450	*12 050 *25,450					*9550 *20,850	*9550 *20,850	5430 210



ISO 10567



* Indicates that the load is limited by hydraulic lifting capacity rather than tipping load. The above loads are in compliance with hydraulic excavator lift capacity standard ISO 10567:2007. They do not exceed 87% of hydraulic lifting capacity or 75% of tipping load. Weight of all lifting accessories must be deducted from the above lifting capacities. Lifting capacities are based on the machine standing on a firm, uniform supporting surface. The use of a work tool attachment point to handle/lift objects, could affect the machine lift performance.

Lift capacity stays with $\pm 5\%$ for all available track shoes.

Always refer to the appropriate Operation and Maintenance Manual for specific product information.

336F L XE Hydraulic Excavator Specifications

ES Reach Boom Lift Capacities – Counterweight: 6.1 mt (6.7 t) – Heavy Lift: On

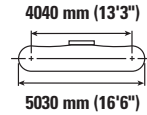
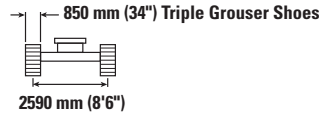
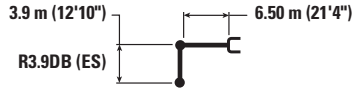

Reach Boom	1500 mm/60 in		3000 mm/120 in		4500 mm/180 in		6000 mm/240 in		7500 mm/300 in		9000 mm/360 in		mm in			
	kg lb	kg lb	kg lb	kg lb	kg lb	kg lb	kg lb	kg lb	kg lb	kg lb	kg lb	kg lb	kg lb	mm in		
9000 mm 360 in													*6000 *13,300	*6000 *13,300	7350 290	
7500 mm 300 in									*7350 *16,200	*7350 *16,200			*5550 *12,300	*5550 *12,300	8540 340	
6000 mm 240 in									*7650 *16,700	*7650 *16,700	*7200 *13,900	6050 12,950	*5400 *11,900	*5400 *11,900	9340 370	
4500 mm 180 in							*9350 *20,250	*9350 *20,250	*8350 *18,150	7950 17,150	*17,000 *12,750	5950 12,750	*5400 *11,900	*5100 *11,250	9840 390	
3000 mm 120 in					*14 650 *31,500	*14 650 *31,500	*11 050 *23,900	10 600 22,850	*9250 *20,100	7600 16,400	*8250 *17,950	5750 12,400	*5600 *12,250	4800 10,500	10 100 400	
1500 mm 60 in					*17 650 *38,050	15 050 32,400	*12 700 *27,450	10 000 21,550	*10 200 *22,100	7300 15,700	*8750 *18,850	5600 12,000	*5900 *13,000	4650 10,250	10 130 400	
0 mm 0 in			*8200 *18,650	*8200 *18,650	*19 200 *41,500	14 350 30,900	*13 850 *29,950	9550 20,550	*10 900 *23,650	7000 15,100	*8600 *18,500	5450 11,650	*6450 *14,200	4700 10,350	9930 390	
-1500 mm -60 in	kg lb	*8600 *19,150	*8600 *19,150	*12 850 *29,050	*12 850 *29,050	*19 400 *42,050	14 100 30,300	*14 250 *30,900	9300 20,050	11 050 23,800	6850 14,750	8500 18,350	5350 11,500	*7350 *16,200	5000 11,000	9490 380
-3000 mm -120 in	kg lb	*13 600 *30,450	*13 600 *30,450	*18 750 *42,450	*18 750 *42,450	*18 550 *40,200	14 100 30,350	*13 900 *30,100	9250 19,950	*10 900 *23,450	6800 14,700			*8800 *19,350	5550 12,300	8770 350
-4500 mm -180 in	kg lb	*19 550 *43,950	*19 550 *43,950	*22 900 *49,450	*22 900 *49,450	*16 550 *35,600	14 350 30,850	*12 500 *26,850	9400 20,250	*9400 *19,750	6950 15,050			*8950 *19,700	6750 15,050	7690 300
-6000 mm -240 in	kg lb					*12 550 *26,450	*12 550 *26,450	*8850 *8850						*8700 *19,050	*8700 *19,050	6060 240

ES Reach Boom Lift Capacities – Counterweight: 6.1 mt (6.7 t) – Heavy Lift: On

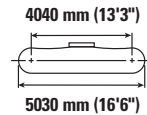
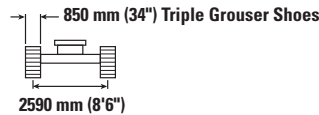
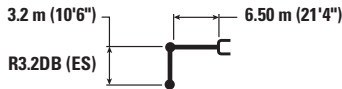

Reach Boom	3000 mm/120 in		4500 mm/180 in		6000 mm/240 in		7500 mm/300 in		9000 mm/360 in		mm in		
	kg lb	kg lb	kg lb	kg lb	kg lb	kg lb	kg lb	kg lb	kg lb	kg lb	kg lb	mm in	
7500 mm 300 in							*8400 8200				*7150 *15,800	*7150 *15,800	7700 300
6000 mm 240 in							*8500 *18,650	8150 17,450			*6950 *15,300	6500 14,400	8580 340
4500 mm 180 in			*13 000 *28,600	*13 000 *28,600	*10 450 *22,600	*10 450 *22,600	*9150 *19,900	7900 16,950	*8200 *17,600	5900 12,950	*7000 *15,400	5750 12,750	9130 360
3000 mm 120 in			*16 400 *35,300	15 800 34,100	*12 050 *26,100	10 450 22,550	*10 000 *21,650	7600 16,300	*8850 *19,250	5750 12,400	*7250 *15,950	5400 11,850	9410 370
1500 mm 60 in			*18 900 *40,750	14 800 31,900	*13 500 *29,200	9900 21,400	*10 800 *23,350	7300 15,700	8800 18,950	5600 12,100	*7800 *17,100	5250 11,550	9440 380
0 mm 0 in			*19 700 *42,600	14 350 30,950	*14 300 *31,000	9600 20,650	*11 300 *24,300	7100 15,250	8700 18,700	5500 11,850	8400 18,500	5350 11,750	9220 370
-1500 mm -60 in	kg lb	*14 050 *31,800	*14 050 *31,800	*19 300 *41,800	14 300 30,700	*14 400 *31,200	9450 20,300	11 200 24,050	6950 15,000		9000 19,900	5700 12,550	8750 350
-3000 mm -120 in	kg lb	*22 150 *50,150	*22 150 *50,150	*17 900 *38,700	14 400 30,950	*13 600 *29,400	9450 20,400	*10 550 *22,600	7000 15,150		*9650 *21,200	6500 14,400	7960 320
-4500 mm -180 in	kg lb	*20 050 *43,200	*20 050 *43,200	*15 150 *32,500	14 700 31,700	*11 450 *24,400	9700 20,900				*9650 *21,250	8300 18,600	6750 270



ISO 10567



* Indicates that the load is limited by hydraulic lifting capacity rather than tipping load. The above loads are in compliance with hydraulic excavator lift capacity standard ISO 10567:2007. They do not exceed 87% of hydraulic lifting capacity or 75% of tipping load. Weight of all lifting accessories must be deducted from the above lifting capacities. Lifting capacities are based on the machine standing on a firm, uniform supporting surface. The use of a work tool attachment point to handle/lift objects, could affect the machine lift performance.

Lift capacity stays with ±5% for all available track shoes.

Always refer to the appropriate Operation and Maintenance Manual for specific product information.

336F L XE Hydraulic Excavator Specifications

Work Tool Offering Guide*

Boom Options	Reach Boom HD 6.50 m (21'4")			Reach Boom HD 6.50 m (21'4")		Reach Boom ES 6.50 m (21'4")		Mass Boom 6.18 m (20'3")	
Stick Options	2.8 (9'2")	3.9 (12'10")	3.2 (10'6")	3.9 (12'10")	3.2 (10'6")	3.9 ES (12'10")	3.2 ES (10'6")	2.55 (8'4")	
Counterweight	5.1 mt (5.6 t)			6.1 mt (6.7 t)		6.1 mt (6.7 t)		6.1 mt (6.7 t)	
Hydraulic Hammers	H140E s H160E s	H140E s H160E s	H140E s H160E s	H140E s H160E s	H140E s H160E s	H140E s H160Es	H140E s H160E s	H140E s H160E s	
Multi-Processors	MP324 CC Jaw MP324 D Jaw MP324 P Jaw MP324 S Jaw MP324 TS Jaw MP324 U Jaw MP30 CC Jaw MP30 CR Jaw MP30 PS Jaw	MP324 CC Jaw MP324 D Jaw MP324 P Jaw MP324 S Jaw MP324 TS Jaw MP324 U Jaw MP30 CC Jaw MP30 CR Jaw MP30 PP Jaw MP30 PS Jaw MP30 S Jaw MP30 TS Jaw	MP324 CC Jaw MP324 D Jaw MP324 P Jaw MP324 S Jaw MP324 TS Jaw MP324 U Jaw MP30 CC Jaw MP30 CR Jaw MP30 PP Jaw MP30 PS Jaw MP30 S Jaw MP30 TS Jaw	MP324 CC Jaw MP324 D Jaw MP324 P Jaw MP324 S Jaw MP324 TS Jaw MP324 U Jaw MP30 CC Jaw MP30 CR Jaw MP30 PP Jaw MP30 PS Jaw MP30 S Jaw MP30 TS Jaw	MP324 CC Jaw MP324 D Jaw MP324 P Jaw MP324 S Jaw MP324 TS Jaw MP324 U Jaw MP30 CC Jaw MP30 CR Jaw MP30 PP Jaw MP30 PS Jaw MP30 S Jaw MP30 TS Jaw	MP324 CC Jaw MP324 D Jaw MP324 P Jaw MP324 S Jaw MP324 TS Jaw MP324 U Jaw MP30 CC Jaw MP30 CR Jaw MP30 PP Jaw MP30 PS Jaw MP30 S Jaw MP30 TS Jaw	MP324 CC Jaw MP324 D Jaw MP324 P Jaw MP324 S Jaw MP324 TS Jaw MP324 U Jaw MP30 CC Jaw MP30 CR Jaw MP30 PP Jaw MP30 PS Jaw MP30 S Jaw MP30 TS Jaw	MP324 CC Jaw MP324 D Jaw MP324 P Jaw MP324 S Jaw MP324 TS Jaw MP324 U Jaw MP30 CC Jaw MP30 CR Jaw MP30 PP Jaw MP30 PS Jaw MP30 S Jaw MP30 TS Jaw	MP30 CC Jaw MP30 CR Jaw MP30 PP Jaw MP30 PS Jaw MP30 S Jaw MP30 TS Jaw
Pulverizers	P225 P235	P225 P235	P225 P235	P225 P235	P225 P235	P225 P235	P225 P235	P225 P235	
Demolition and Sorting Grapples	G325B-D/R G330	G325B-D/R G330	G325B-D/R G330	G325B-D/R G330	G325B-D/R G330	G325B-D/R G330	G325B-D/R G330	G330	
Scrap and Demolition Shears	S325B S365C	S325B S365C	S325B S365C	S325B S365C	S325B S340B S365C	S325B S365C	S325B S340B S365C	S340B S365C	
Compactors (Vibratory Plate)	CVP110	CVP110	CVP110	CVP110	CVP110	CVP110	CVP110	CVP110	
Orange Peel Grapples	<p>These work tools are available for the 336F L XE. Consult your Cat dealer for proper match.</p>								
Rippers									
Pin Grabber									
Couplers									

*Matches are dependent on excavator configurations. Consult your Cat dealer for proper work tool match.

Note: Demolition and Sorting Grapples: D – Demolition shells, R – Recycling shells

336F L XE Hydraulic Excavator Specifications

Bucket Specifications and Compatibility

Counterweight	Linkage	Width		Capacity		Weight		Fill	600 mm (24") Triple Grouser				850 mm (34") Triple Grouser		850 mm (34") Triple Grouser			
		mm	in	m ³	yd ³	kg	lb		%	Reach Boom HD 6.50 m (21'4")		ME Boom 6.18 m (20'3")	Reach Boom HD 6.50 m (21'4")		Reach Boom ES 6.50 m (21'4")		ME Boom 6.18 m (20'3")	
		R2.8DB (9'2")	R3.2DB (10'6")	R3.9DB (12'10")	M2.55 TB (8'4")	R3.2DB (10'6")	R3.9DB (12'10")		R3.2DB ES (10'6")	R3.9DB ES (12'10")	M2.55 TB (8'4")							
DB Linkage Without Quick Coupler																		
General Duty (GD)	DB	1350	53	1.64	2.14	1173	2,585	100	●	●	⊙		●	⊙	●	●		
	DB	1650	65	2.11	2.76	1352	2,979	100	⊙	⊙	⊖		⊙	⊖	⊙	⊖		
	DB	1800	71	2.35	3.08	1453	3,202	100	⊖	⊖	○		⊖	○	⊖	○		
	TB	1500	60	2.14	2.80	1872	4,126	100				⊙					●	
	TB	1500	60	2.14	2.80	1996	4,189	100				⊖						●
General Duty (GDC)	TB	1650	66	2.41	3.16	2027	4,468	100				⊖					⊙	
	DB	750	30	0.94	1.23	952	2,099	100	●	●	●		●	●	●	●		
	DB	900	36	1.19	1.56	1040	2,292	100	●	●	●		●	●	●	●		
	DB	1050	42	1.46	1.91	1147	2,528	100	●	●	●		●	●	●	●		
	DB	1200	48	1.73	2.26	1232	2,716	100	●	●	⊙		●	●	●	●		
	DB	1350	54	2.00	2.62	1342	2,957	100	⊙	⊙	⊖		⊙	⊖	●	⊖		
Heavy Duty (HD)	DB	1500	60	2.27	2.98	1451	3,197	100	⊖	⊖	○		⊖	○	⊙	⊖		
	DB	1650	66	2.55	3.33	1536	3,386	100	⊖	○	◇		○	◇	⊖	○		
	DB	750	30	0.73	0.95	1031	2,273	100	●	●	●		●	●	●	●		
	DB	900	36	0.95	1.24	1178	2,595	100	●	●	●		●	●	●	●		
	DB	1050	42	1.17	1.54	1267	2,793	100	●	●	●		●	●	●	●		
	DB	1200	48	1.40	1.84	1398	3,080	100	●	●	●		●	●	●	●		
	DB	1350	54	1.64	2.14	1481	3,265	100	●	●	⊙		●	⊙	●	⊙		
	DB	1350	54	1.64	2.14	1459	3,215	100	●	●	⊙		●	⊙	●	●		
	DB	1400	55	1.64	2.14	1460	3,218	100	●	●	⊙		●	⊙	●	●		
	DB	1500	60	1.88	2.46	1600	3,526	100	⊙	⊙	⊖		⊙	⊖	●	⊖		
	DB	1500	60	1.88	2.46	1566	3,452	100	⊙	⊙	⊖		⊙	⊖	●	⊖		
	DB	1550	61	1.88	2.46	1553	3,423	100	⊙	⊙	⊖		⊙	⊖	●	⊖		
	DB	1650	66	2.12	2.77	1730	3,814	100	⊖	⊖	○		⊖	○	⊙	⊖		
	DB	1650	66	2.12	2.77	1697	3,740	100	⊖	⊖	○		⊖	○	⊙	⊖		
DB	1700	67	2.12	2.77	1647	3,630	100	⊙	⊖	○		⊖	○	⊙	⊖			
DB	1800	72	2.36	3.08	1851	4,080	100	⊖	○	◇		○	◇	⊖	○			
TB	1650	66	2.41	3.16	2210	4,871	100				○					⊙		
TB	1650	66	2.41	3.16	2259	4,979	100				○						⊙	
Severe Duty (SD)	DB	750	30	0.73	0.95	1096	2,415	90	●	●	●		●	●	●	●		
	DB	900	36	0.95	1.24	1252	2,760	90	●	●	●		●	●	●	●		
	DB	1050	42	1.17	1.54	1353	2,981	90	●	●	●		●	●	●	●		
	DB	1200	48	1.40	1.84	1493	3,292	90	●	●	●		●	●	●	●		
	DB	1350	54	1.64	2.14	1599	3,524	90	●	●	⊙		●	⊙	●	●		
	DB	1400	56	1.64	2.14	1643	3,621	90	●	●	⊙		●	⊙	●	●		
	DB	1550	62	1.88	2.46	1787	3,939	90	●	⊙	⊖		⊙	⊖	●	⊙		
	DB	1650	66	2.14	2.81	1827	4,028	90	⊙	⊖	○		⊖	○	●	⊖		
	TB	1350	54	1.87	2.44	2065	4,551	90				●					●	
	TB	1500	60	2.14	2.80	2170	4,783	90				⊙					●	
	TB	1650	66	2.41	3.16	2385	5,257	90				⊖					⊙	
	TB	1650	66	2.41	3.16	2409	5,309	90				⊖					⊙	
Extreme Duty Power (XDP)	DB	1200	48	1.41	1.85	1656	3,650	90	●	●	●		●	●	●	●		
	DB	1400	56	1.64	2.14	1852	4,083	90	●	●	⊙		●	⊙	●	⊙		
	TB	1550	61	2.00	2.59	2516	5,545	90				⊖					●	
Maximum load pin-on (payload + bucket)									kg	5282	5062	4390	5572	5055	4415	5454	4737	6396
									lb	11,642	11,157	9,676	12,281	11,141	9,731	12,021	10,440	14,097

Maximum Material Density:

- 2100 kg/m³ (3,500 lb/yd³)
- ⊙ 1800 kg/m³ (3,000 lb/yd³)
- ⊖ 1500 kg/m³ (2,500 lb/yd³)
- 1200 kg/m³ (2,000 lb/yd³)
- ◇ 900 kg/m³ (1,500 lb/yd³)

The above loads are in compliance with hydraulic excavator standard EN474, they do not exceed 87% of hydraulic lifting capacity or 75% of tipping capacity with front linkage fully extended at ground line with bucket curled.

Capacity based on ISO 7451.

Bucket weight with General Duty tips.

Caterpillar recommends using appropriate work tools to maximize the value customers receive from our products. Use of work tools, including buckets, which are outside of Caterpillar's recommendations or specifications for weight, dimensions, flows, pressures, etc. may result in less-than-optimal performance, including but not limited to reductions in production, stability, reliability, and component durability. Improper use of a work tool resulting in sweeping, prying, twisting and/or catching of heavy loads will reduce the life of the boom and stick.

336F L XE Hydraulic Excavator Specifications

Bucket Specifications and Compatibility

	Linkage	Width		Capacity		Weight		Fill	600 mm (24") Triple Grouser				850 mm (34") Triple Grouser		850 mm (34") Triple Grouser			
		mm	in	m ³	yd ³	kg	lb		5.1 mt (5.6 t)				5.1 mt (5.6 t)		6.1 mt (6.7 t)			
									Reach Boom HD 6.50 m (21'4")		ME Boom 6.18 m (20'3")	Reach Boom HD 6.50 m (21'4")		Reach Boom ES 6.50 m (21'4")		ME Boom 6.18 m (20'3")		
									R2.8DB (9'2")	R3.2DB (10'6")	R3.9DB (12'10")	M2.55 TB (8'4")	R3.2DB (10'6")	R3.9DB (12'10")	R3.2DB ES (10'6")	R3.9DB ES (12'10")	M2.55 TB (8'4")	
DB Linkage With Pin Grabber Coupler																		
General Duty (GD)	DB	1350	53	1.64	2.14	1173	2,585	100	●	●	⊖		●	⊖	●	⊙		
	DB	1650	65	2.11	2.76	1352	2,979	100	⊖	⊖	○		⊖	○	⊖	○		
	DB	1800	71	2.35	3.08	1453	3,202	100	○	○	◇		○	◇	⊖	○		
	TB	1500	60	2.14	2.80	1872	4,126	100				⊖					⊙	
	TB	1500	60	2.14	2.80	1996	4,189	100				○						⊙
General Duty (GDC)	TB	1650	66	2.41	3.16	2027	4,468	100				○					⊖	
	DB	750	30	0.94	1.23	952	2,099	100	●	●	●		●	●	●	●		
	DB	900	36	1.19	1.56	1040	2,292	100	●	●	●		●	●	●	●		
	DB	1050	42	1.46	1.91	1147	2,528	100	●	●	⊙		●	⊙	●	●		
	DB	1200	48	1.73	2.26	1232	2,716	100	●	⊙	⊖		⊙	⊖	●	⊖		
	DB	1350	54	2.00	2.62	1342	2,957	100	⊖	⊖	○		⊖	○	⊙	○		
Heavy Duty (HD)	DB	1500	60	2.27	2.98	1451	3,197	100	⊖	○	◇		○	◇	⊖	○		
	DB	1650	66	2.55	3.33	1536	3,386	100	○	○	◇		○	◇	○	◇		
	DB	750	30	0.73	0.95	1031	2,273	100	●	●	●		●	●	●	◇		
	DB	900	36	0.95	1.24	1178	2,595	100	●	●	●		●	●	●	●		
	DB	1050	42	1.17	1.54	1267	2,793	100	●	●	●		●	●	●	●		
	DB	1200	48	1.40	1.84	1398	3,080	100	●	●	⊙		●	⊙	●	⊙		
	DB	1350	54	1.64	2.14	1481	3,265	100	⊙	⊙	⊖		⊙	⊖	●	⊖		
	DB	1350	54	1.64	2.14	1459	3,215	100	⊙	⊙	⊖		⊙	⊖	●	⊖		
	DB	1400	55	1.64	2.14	1460	3,218	100	⊙	⊙	⊖		⊙	⊖	●	⊖		
	DB	1500	60	1.88	2.46	1600	3,526	100	⊖	⊖	○		⊖	○	⊙	○		
	DB	1500	60	1.88	2.46	1566	3,452	100	⊖	⊖	○		⊖	○	⊙	○		
	DB	1550	61	1.88	2.46	1553	3,423	100	⊖	⊖	○		⊖	○	⊙	○		
	DB	1650	66	2.12	2.77	1730	3,814	100	○	○	◇		○	◇	⊖	○		
	DB	1650	66	2.12	2.77	1697	3,740	100	⊖	○	◇		○	◇	⊖	○		
	DB	1700	67	2.12	2.77	1647	3,630	100	⊖	○	◇		○	◇	⊖	○		
	DB	1800	72	2.36	3.08	1851	4,080	100	○	◇	X		◇	X	○	◇		
	TB	1650	66	2.41	3.16	2210	4,871	100				○					⊖	
TB	1650	66	2.41	3.16	2259	4,979	100				○					⊖		
TB	1750	70	2.60	3.40	2240	4,936	100				◇					○		
TB	1800	72	2.69	3.52	2423	5,340	100				◇					○		
TB	1800	72	2.69	3.52	2381	5,248	100				◇					○		
Severe Duty (SD)	DB	750	30	0.73	0.95	1096	2,415	90	●	●	●		●	●	●	●		
	DB	900	36	0.95	1.24	1252	2,760	90	●	●	●		●	●	●	●		
	DB	1050	42	1.17	1.54	1353	2,981	90	●	●	●		●	●	●	●		
	DB	1200	48	1.40	1.84	1493	3,292	90	●	●	⊙		●	⊙	●	●		
	DB	1350	54	1.64	2.14	1599	3,524	90	●	⊙	⊖		⊙	⊖	●	⊙		
	DB	1400	56	1.64	2.14	1643	3,621	90	●	⊙	⊖		⊙	⊖	●	⊙		
	DB	1550	62	1.88	2.46	1787	3,939	90	⊙	⊖	○		⊖	○	⊙	○		
	DB	1650	66	2.15	2.81	1827	4,028	90	⊖	○	◇		○	◇	⊖	○		
	TB	1350	54	1.87	2.44	2065	4,551	90				⊙					●	
	TB	1500	60	2.14	2.80	2170	4,783	90				⊖					⊙	
	TB	1650	66	2.41	3.16	2385	5,257	90				○					⊖	
	TB	1650	66	2.41	3.16	2409	5,309	90				○					⊖	
Extreme Duty Power (XDP)	DB	1200	48	1.41	1.85	1656	3,650	90	●	●	⊙		●	⊙	●	⊙		
	DB	1400	56	1.64	2.14	1852	4,083	90	⊙	⊙	○		⊙	○	●	⊖		
	TB	1550	61	2.00	2.59	2516	5,545	90				○					⊙	
Maximum load pin-on (payload + bucket)									kg	4724	4504	3832	5014	4497	3857	4896	4179	5838
									lb	10,412	9,927	8,446	11,051	9,911	8,501	10,791	9,210	12,867

Maximum Material Density:

- 2100 kg/m³ (3,500 lb/yd³)
- ⊙ 1800 kg/m³ (3,000 lb/yd³)
- ⊖ 1500 kg/m³ (2,500 lb/yd³)
- 1200 kg/m³ (2,000 lb/yd³)
- ◇ 900 kg/m³ (1,500 lb/yd³)
- X Not Recommended

The above loads are in compliance with hydraulic excavator standard EN474, they do not exceed 87% of hydraulic lifting capacity or 75% of tipping capacity with front linkage fully extended at ground line with bucket curled.

Capacity based on ISO 7451.

Bucket weight with General Duty tips.

Caterpillar recommends using appropriate work tools to maximize the value customers receive from our products. Use of work tools, including buckets, which are outside of Caterpillar's recommendations or specifications for weight, dimensions, flows, pressures, etc. may result in less-than-optimal performance, including but not limited to reductions in production, stability, reliability, and component durability. Improper use of a work tool resulting in sweeping, prying, twisting and/or catching of heavy loads will reduce the life of the boom and stick.

Standard Equipment

Standard equipment may vary. Consult your Cat dealer for details.

CAB

- Wiper and washer
- Mirrors
- Pressurized operator station with positive filtration
- Sliding upper door window (left-hand cab door)
- Openable skylight
- Interior:
 - Glass-breaking safety hammer
 - Coat hook
 - Beverage holder
 - Literature holder
 - Interior lighting
 - AM/FM radio
 - Two 12V stereo speakers
 - Storage shelf suitable for lunch or toolbox
 - Power supply with 12V, two power outlets (10 amp)
 - Thumb wheel modulation joystick for use with combined auxiliary control
 - Air conditioner, heater and defroster with climate control
- Seat:
 - Adjustable high-back, heated and ventilated seat with air suspension
 - Seat belt, 51 mm (2 in)
 - Adjustable armrest
 - Height adjustable joystick consoles
 - Neutral lever (lock out) for all controls
 - Travel control pedals with removable hand levers
 - Capability of installing two additional pedals
 - Two speed travel
 - Floor mat, washable

- Monitor:
 - Clock
 - Video ready
 - Color LCD display with warning, filter/fluid change, and working hour information
 - Language display (full graphic and full color display)
 - Machine condition, error code and tool mode setting information
 - Start-up level check for engine oil, engine coolant and hydraulic oil
 - Warning, filter/fluid change and working hour information
 - Fuel consumption meter
- Windshield:
 - 70-30 split, sliding, removable lower windshield with in cab storage bracket
- Straight travel pedal

ELECTRICAL

- 80 amp alternator
- Circuit breaker
- Battery, standard
- Travel alarm

ENGINE

- Cat C9.3 ACERT diesel engine
- Meets Tier 4 Final emissions standards
- 2300 m (7,500 ft) altitude capability with no derate
- Biodiesel capable
- Automatic engine speed control
- Electric priming pump
- Water separator in fuel line including water level sensor and indicator
- Economy and standard power modes
- Air cleaner
- Radial seal air filter
- Side-by-side cooling system
- Primary filter with water separator and water separator indicator switch
- Starting kit, cold weather, -18° C (-0.4° F)
- Fuel differential indicator switch in fuel line
- 2×4 micron main filters and 1×10 micron primary filter in fuel line
- Water level indicator for water separator

HYDRAULIC SYSTEM

- Automatic swing parking brake
- High-performance hydraulic return filter
- Regeneration circuit for boom and stick
- Capability of installing additional auxiliary circuits
- Bio oil capable

LIGHTS

- Cab and boom lights with time delay
- Exterior lights integrated into storage box
- Cab working lights, halogen

UNDERCARRIAGE/UPPERFRAME

- Grease Lubricated Track GLT2, resin seal
- Heavy duty track roller and idler
- Towing eye on base frame
- Swivel guard
- Heavy duty bottom guard
- Heavy duty travel motor guard

SAFETY AND SECURITY

- Cat one key security system
- Door locks
- Cap locks on fuel and hydraulic tanks
- Lockable external tool/storage box
- Signaling/warning horn
- Secondary engine shutoff switch
- Mirrors
- Rear window for emergency exit
- Rear vision camera
- Capability to connect a beacon
- Bolt on FOGS capability

INTEGRATED TECHNOLOGIES

- Product Link
- Rear vision camera
- Cat Grade 2D
- Cat Production Measurement

Optional Equipment

Optional equipment may vary. Consult your Cat dealer for details.

FRONT LINKAGE

- Extreme Service Reach Boom 6.5 m (21'4")*
 - ES R3.9 DB (12'10")*
 - ES R3.2 DB (10'6")*
 - DB-family bucket linkage (with lifting eye)
- Heavy Duty Reach Boom 6.5 m (21'4")
 - HD R3.9 DB (12'10")
 - HD R3.2 DB (10'6")
 - HD R2.8 DB (10'6")**
 - DB-family bucket linkage (with lifting eye)
- Mass boom 6.18 m (20'3")
 - M2.55 TB (8'4")
 - TB-family bucket linkage (with lifting eye)
- Pin Grabber couplers

TRACK

- 600 mm (24") Double Grouser**
- 600 mm (24") Triple Grouser**
- 700 mm (28") Triple Grouser**
- 850 mm (34 in) Triple Grouser
- 800 mm (32 in) Triple Grouser

COUNTERWEIGHT

- 5.1 mt (5.6 t) counterweight
- 6.1 mt (6.7 t) counterweight

*For AmN only.

**For ANZ only.

GUARDS

- Rubber bumpers
- FOGS (Falling Object Guard System) including overhead and windshield guards
- Mesh guard
- Vandalism guard
- Track guiding guards
 - Segmented
 - Center
 - Full length**

CAB

- Sun screen

HYDRAULIC SYSTEM

- Boom and stick lowering control devices with SmartBoom
- HP hydraulic lines for boom and stick
- MP hydraulic lines for boom and stick
- QC hydraulic lines for boom and stick
- QC control
- Bio oil
- Control Pattern Quick Changer

ELECTRICAL

- Cold weather starting package

ENGINE

- Quick drains, engine and hydraulic oil (QuickEvac)

SAFETY AND SECURITY

- Cat MSS (anti-theft device)

INTEGRATED TECHNOLOGIES

- Cat Grade with Assist (field installed kit)
- Cat Grade 3D

For more complete information on Cat products, dealer services, and industry solutions, visit us on the web at www.cat.com

AEHQ7944
(AmN, ANZ)

© 2017 Caterpillar
All rights reserved

Materials and specifications are subject to change without notice. Featured machines in photos may include additional equipment. See your Cat dealer for available options.

CAT, CATERPILLAR, SAFETY.CAT.COM, their respective logos, "Caterpillar Yellow" and the "Power Edge" trade dress, as well as corporate and product identity used herein, are trademarks of Caterpillar and may not be used without permission.

VisionLink is a trademark of Trimble Navigation Limited, registered in the United States and in other countries.

